



# Origins™

BY TIMBERLAKE



# Table of Contents

## Door Finishes

White ..... 06  
Pebble ..... 08  
Umber ..... 10  
At a Glance ..... 12

## Product Specifications

An Inside Look ..... 16  
Cabinet Face Dimensions ..... 18  
Wall Cabinets ..... 20  
Base Cabinets ..... 21  
Vanity Cabinets ..... 22  
Accessory Items ..... 23  
Molding ..... 25  
Hardware ..... 26  
Functional Kitchen Additions ..... 28  
Important Information ..... 30



# The Timberlake® Advantage



## Your trusted partner

We're proactive, planning ahead to prevent problems instead of just reacting to them. We design to save money, schedule to make every minute count, and install for one-trip satisfaction.



## We focus on cabinets

That's all we've done for the past three decades. When you team up with Timberlake, you benefit from years of experience and refinement. That means high-quality materials, craftsmanship, and service—start to finish.



## Quality meets value

Origins by Timberlake showcases modern styling in an economical design offering. We make it easy to choose the perfect combination of features for your needs and budget.



# Door Finishes

Origins by Timberlake boasts one door style in three on-trend, designer-favorite finishes - White, Pebble, and Umber - that combine style with affordability.



Chatham Pebble





## Features

### Construction

Routed MDF  
Recessed panel

### Door Details

Full overlay

### Finish

Thermofoil

### Hardware

Required



# White

## Chatham Door Style

The color white has a remarkable impact on any living space, with its pure and pristine quality. It makes any room appear larger and more inviting, saturating its environment with a sense of spaciousness and airiness. White is timeless and elegant, providing a blank canvas that harmonizes effortlessly with various design styles and color schemes. Its clean and bright aesthetic fosters a sense of serenity and freshness, especially in spaces such as kitchens. White is a versatile choice that allows for creativity and personalization, whether through contrasting accents or a minimalist, contemporary vibe.



Chatham White



## Features

### Construction

Routed MDF  
Recessed panel

### Door Details

Full overlay

### Finish

Thermofoil

### Hardware

Required



# Pebble

## Chatham Door Style

Pebble is a fusion of warm brown and subtle gray, creating a unique and versatile aesthetic. The result is a rich, earthy hue that emanates a sense of comfort and sophistication. This finish strikes a harmonious balance between traditional and contemporary design, making it an ideal option for a variety of decor styles.





Chatham Pebble



## Features

### Construction

Mortise & Tenon

### Door Details

Full Overlay

### Finish

Stain

### Hardware

Required



# Umber

## Chatham Door Style

Umber gives a timeless elegance and warmth. It highlights the natural beauty of wood through its deep, earthy tones that convey a sense of authenticity and comfort. The intricate patterns and texture create a rich tactile and visual experience, making any space feel welcoming and cozy. Umber not only offers a classic and enduring appeal but also adds a touch of luxury.



Chatham Umber



# At a Glance

## Care & Cleaning

While our laminate, staining, and wood finishing processes promote durability, care should be taken to preserve the original factory finish:

- Wipe up spills immediately
- Use mild soaps only
- Be sure to read all cabinet care guidelines and cleaning product instructions carefully

## Choose Your Material



### Hardwood

Hardwood cabinetry has a dense structure and comes from a combination of deciduous trees such as maple, beech, birch, or poplar. Natural colors range from light blonde to dark reddish-brown tones. These hardwoods may contain mineral streaks, slight differences in graining, and color variations.

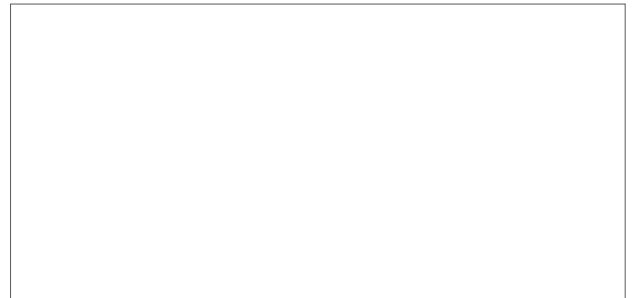

### Thermofoil

Thermofoil is a process whereby a thick vinyl film is bonded permanently to a warp-resistant engineered wood core. Because the color is consistent throughout the film, the surface is durable, easy to clean, and resistant to chipping and cracking.

# Chatham Finishes

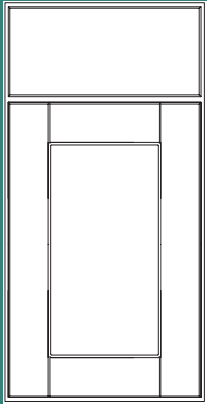

**Door:** Recessed Panel  
**Overlay:** Full Overlay  
**Construction:** Routed MDF  
**Hardware:** Required



White Thermofoil  
1SSW



Pebble Thermofoil  
1SDV

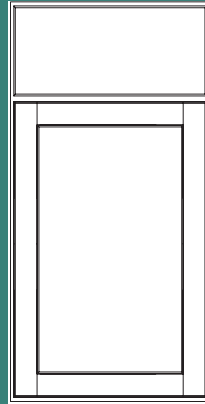

**Door:** Recessed Panel  
**Overlay:** Full Overlay  
**Construction:** Hardwood  
Mortise & Tenon  
**Hardware:** Required

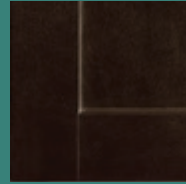

Umber Stain  
1SJM



Chatham Pebble



# Product Specs

Create the kitchen that perfectly fits your lifestyle. You'll find the quality construction and features at prices that help you get the most kitchen for your budget—and years of enjoyment.



Chatham Umber





# An Inside Look

All cabinetry manufactured by Timberlake is certified by the Kitchen Cabinet Manufacturers Association (KCMA).

Timberlake has received certification by KCMA Environmental Stewardship Program on all products.



KITCHEN CABINET MANUFACTURERS ASSOCIATION

KITCHEN CABINET MANUFACTURERS ASSOCIATION  
ENVIRONMENTAL STEWARDSHIP PROGRAM CERTIFIED  
ALL PRODUCTS SERVICE THE ENVIRONMENT  
FOR EEP PROGRAM DETAILS, VISIT [KCMAS.ORG](http://KCMAS.ORG)

## Cabinet Opening Dimensions

Illustrations specify dimensions of vertical stiles and horizontal rails, inset toe kick, and standard interior opening heights.

When selecting cabinetry for installation above or near any appliance, refer to the appliance manufacturer's specification for clearance and venting requirements.

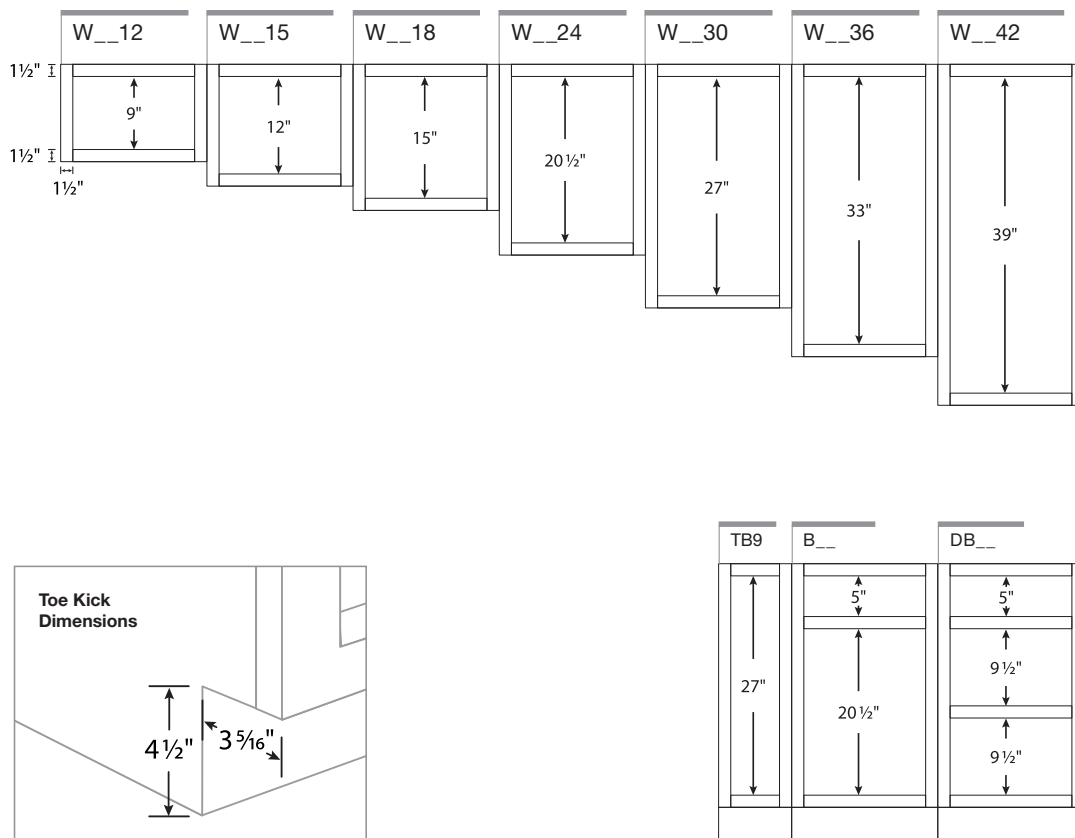



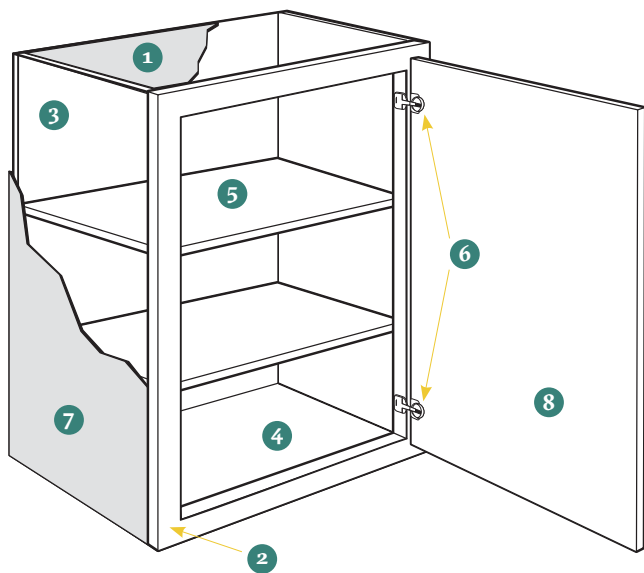

## Wall Cabinets

- 1 **Top/Bottom Panels:**  $\frac{3}{8}$ " engineered wood
- 2 **Face Frame:**  $1\frac{1}{2}$ " wide frame material
- 3 **Back Panel:** Full  $\frac{3}{8}$ " back panel
- 4 **Interiors:** Natural wood-grain laminate finish on engineered wood
- 5 **Shelves:**  $\frac{3}{4}$ " thick adjustable shelves
- 6 **Hinges:** Fully concealed and adjustable
- 7 **End Panels:**  $\frac{1}{2}$ " engineered wood with laminated exterior to match cabinet finish
- 8 **Door:** Reversible door on single-door cabinets for left or right opening; hinged on the left from the factory; double-door cabinets are butt doors with no center stile

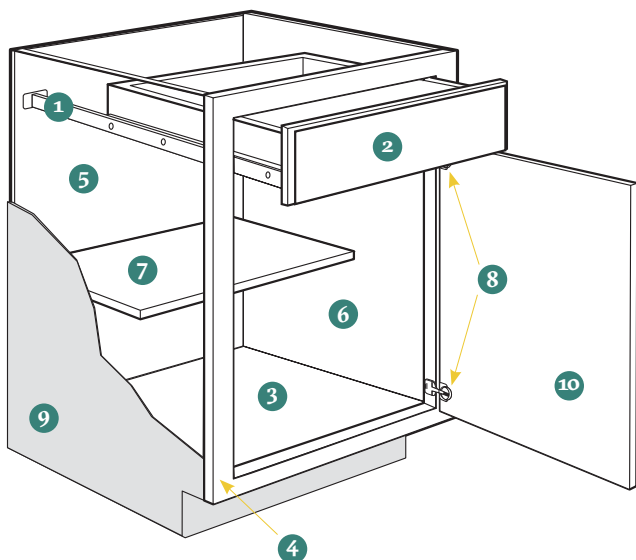

## Base Cabinets

- 1 **Drawer Glides:**  $\frac{3}{4}$ " access ball bearing
- 2 **Drawer Box:** Hardwood, 4-sided drawer box with fully encapsulated bottom
- 3 **Bottom Panels:**  $\frac{3}{8}$ " engineered wood
- 4 **Face Frame:**  $1\frac{1}{2}$ " wide frame material
- 5 **Back Panel:** Full  $\frac{3}{8}$ " back panel with a natural laminate interior
- 6 **Interiors:** Natural wood-grain laminate finish on engineered wood
- 7 **Shelf:**  $\frac{3}{4}$ " thick adjustable half-depth shelf
- 8 **Hinges:** Fully concealed and adjustable
- 9 **End Panels:**  $\frac{1}{2}$ " engineered wood with laminated exterior to match cabinet finish
- 10 **Door:** Reversible door on single-door cabinets for left or right opening; hinged on the left from the factory; double-door cabinets are butt doors with no center stile



# Cabinet Face Dimensions

Sized to cover nearly all of the cabinet face frame, full overlay door styles require decorative hardware to complete installation.

## Full Overlay

Full overlay doors are sized to cover nearly all of the cabinet face frame. Full overlay door styles require decorative hardware. To facilitate proper door operation, include

at least a 1" filler between the hinged side of full overlay door styles and deeper adjacent objects including cabinets, walls, appliances, and countertops.

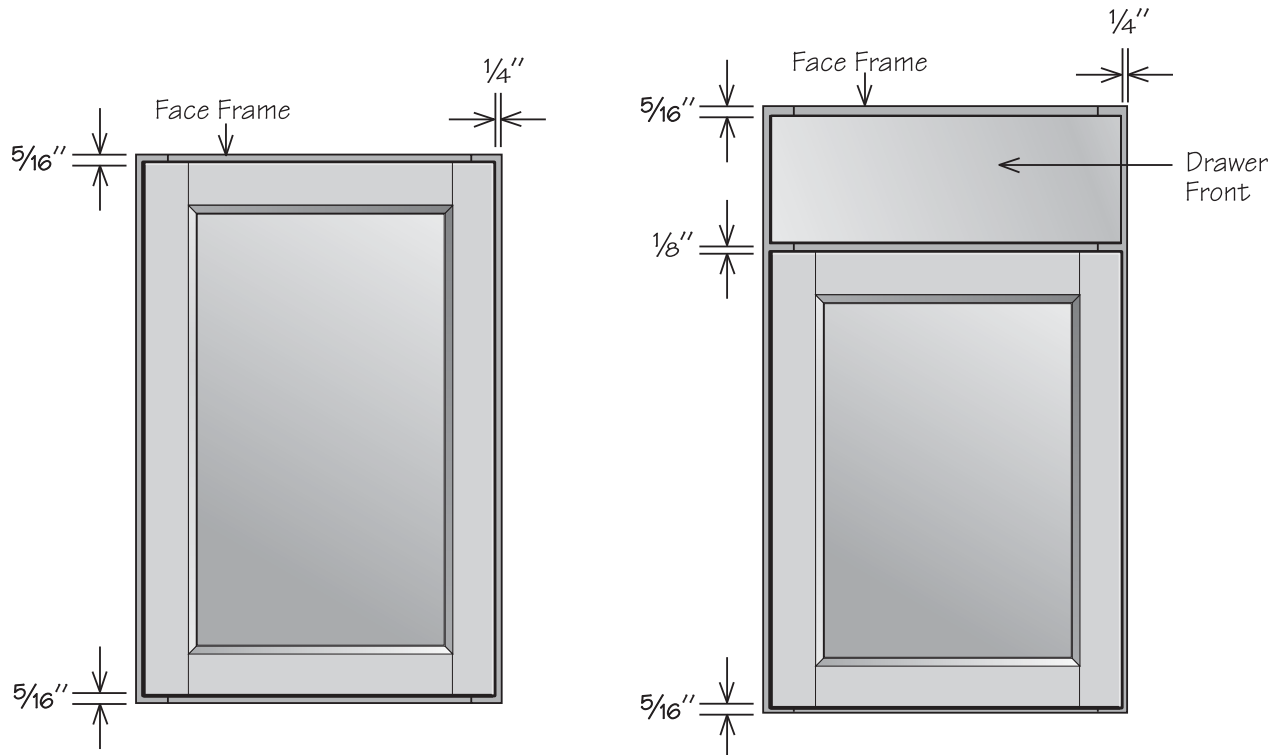



Chatham Pebble



Chatham White



# Wall Cabinet Specifications

## Wall Cabinet | 1 Door

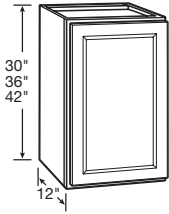

- Includes two adjustable shelves
- Hinged left, field reversible

30" HIGH	36" HIGH	42" HIGH
W1230	W1236	W1242
W1530	W1536	W1542
W1830	W1836	W1842
W2130	W2136	W2142
W2430	W2436	W2442

## Wall Cabinet | 2 Butt Doors

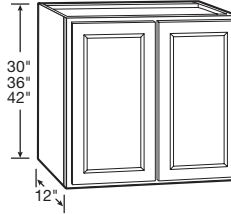

- Includes two adjustable shelves

30" HIGH	36" HIGH	42" HIGH
W2730 BUTT	W2736 BUTT	W2742 BUTT
W3030 BUTT	W3036 BUTT	W3042 BUTT
W3330 BUTT	W3336 BUTT	W3342 BUTT
W3630 BUTT	W3636 BUTT	W3642 BUTT

## Wall Cabinet | 2 Butt Doors

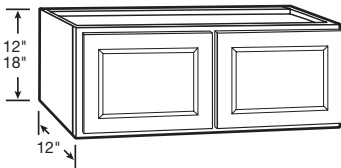

- No shelf

12" HIGH	18" HIGH
W3012 BUTT	W3018 BUTT
W3612 BUTT	W3618 BUTT

## Wall Cabinet | 2 Butt Doors

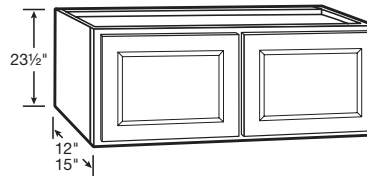

- Includes one adjustable shelf

23 1/2" HIGH						
<table border="0"> <tr> <th>12" Deep</th> <th>15" Deep</th> </tr> <tr> <td>W3024 BUTT</td> <td>W3024 X 15DP BUTT</td> </tr> <tr> <td>W3624 BUTT</td> <td></td> </tr> </table>	12" Deep	15" Deep	W3024 BUTT	W3024 X 15DP BUTT	W3624 BUTT	
12" Deep	15" Deep					
W3024 BUTT	W3024 X 15DP BUTT					
W3624 BUTT						

## Corner Wall Cabinet

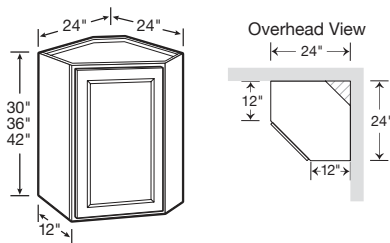

- Installs in a 24" x 24" wall area
- 30" high includes one adjustable shelf
- 36" high and 42" high include two adjustable shelves
- Hinged left, field reversible

30" HIGH	36" HIGH	42" HIGH
CW2430	CW2436	CW2442

## Base Cabinets

### Corner Base Carousel | Spin Unit

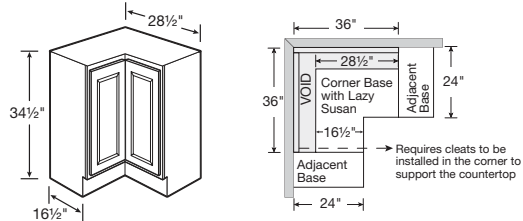

- Installs in a 36" x 36" wall area
- Two-piece overlay door hinged together in the middle
- Two 360° independently rotating metal racks
- Exterior side panels are natural laminate
- Hinged left, reversible in field
- Additional space recommended if appliance is installed on the hinged side of this cabinet for proper door operation
- If unit has an exposed side, order an end panel separately

34 1/2" HIGH
CAR36

**Base | 1 Door and 1 Drawer**

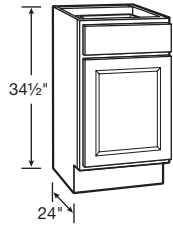

- Ball-bearing drawer glides
- One half-depth adjustable shelf included
- Hinged left, field reversible

**34 1/2" HIGH**

B12	B21
B15	B24
B18	

**Base | 2 Butt Doors and 1 Drawer**

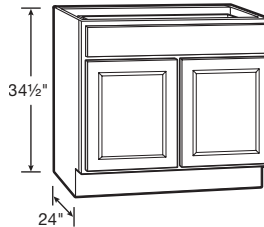

- Ball-bearing drawer glides
- One half-depth adjustable shelf included

**34 1/2" HIGH**

B27 BUTT
B30 BUTT
B33 BUTT
B36 1TD BUTT

**Full-Height Base Cabinet | 1 Door**

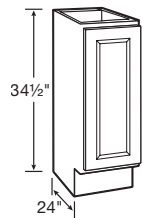

- One half-depth adjustable shelf included
- Hinged left, field reversible

**34 1/2" HIGH**

TB9
-----

**Full-Height Base Cabinet | 1 Door with Wastebasket Pull-Out**

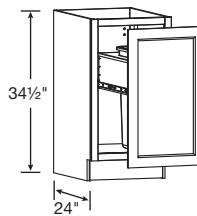

- Includes a 48-quart waste container

**34 1/2" HIGH**

BWBT18-1 FH
-------------

**Drawer Base Cabinet | 3 Drawers**

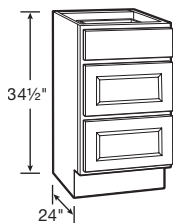

- 18" wide and 24" wide include ball-bearing drawer glides
- 30" wide and 36" wide include full-extension, heavy-duty drawer glides on all three drawers
- Deep drawers feature five-piece drawer fronts

**34 1/2" HIGH**

DB18	DB30
DB24	DB36 1TD

**Sink/Cooktop Base | 2 Butt Doors and 1 Panel**

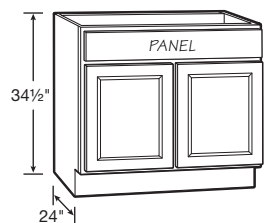

- Full-height back panel
- No shelf
- Subtract 1 1/2" from width and 1 1/8" from depth for available sink bowl opening
- Refer to sink/cooktop manufacturer's specifications for adequate clearance and required installation materials
- Touch-up kit included

**34 1/2" HIGH**

SB30 BUTT TU
SB36 BUTT TU



# Vanity Cabinet Specifications

## Vanity Drawer Base | 3 Drawers

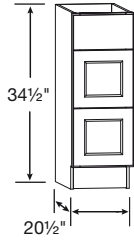

- Deep drawers feature five-piece drawer fronts

### 34 1/2" HIGH

VDB1234H  
VDB1534H  
VDB1834H

## Vanity Sink Base | 2 Butt Doors and 1 Drawer Panel

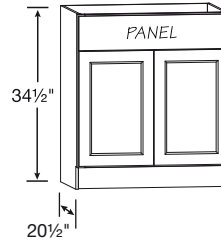

- No shelf
- Subtract 1/2" from width and 1/8" from depth for available sink bowl opening
- Refer to sink manufacturer's specifications for adequate clearance and required installation materials

### 34 1/2" HIGH

VSB2434H BUTT  
VSB2734H BUTT  
VSB3034H BUTT

VSB3334H BUTT  
VSB3634H BUTT

## Oven Cabinet

### Double Oven Cabinet | 2 Butt Doors and 1 Drawer

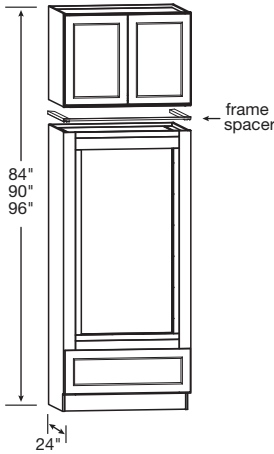

- Includes drawer with full-extension, heavy-duty drawer glides
- Includes 24" deep wall cabinet (ships separately)
- Overhead wall cabinet is not pre-installed to oven cabinet, comes as two pieces, boxed separately
- Rails and stiles around oven opening are trimmable
- Cut-out dimensions:  
Width: 24" minimum, 30" maximum  
Height: 47 5/8" minimum, 52 1/8" maximum
- Frame spacer included in OVD339624 BUTT only
- 96" high double oven overhead wall cabinet is 23 1/2" high

### 84" HIGH

OVD338424 BUTT

### 90" HIGH

OVD339024 BUTT

### 96" HIGH

OVD339624 BUTT

## Accessory Items

### Veneer End Paneling

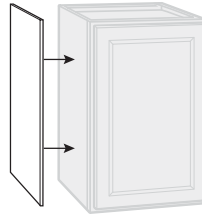

- Finished veneer panels fit flush
- Umber panels feature stained veneers
- White and Pebble panels are laminate
- Wall panels are 1 1/4" deep, 30" or 42" high
- Base panels are 23 1/4" deep x 34 1/2" high
- Finished panel is 48" wide x 34 1/2" high

### WALL PANEL

WEP30  
WEP42

### BASE PANEL

BEP34

### FINISHED PANELING

FP4834

**Refrigerator Return Kit**

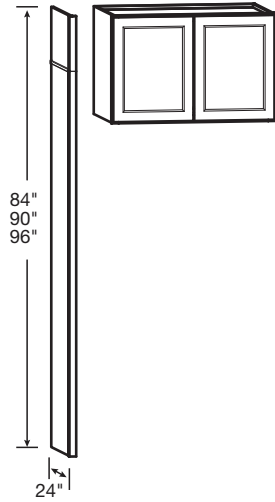

- Kit includes one 84" tall end panel, one 12" tall panel, one 6" tall panel, and one piece of scribe molding
- Kits and Wall Cabinets combine to achieve 84", 90", or 96" overall heights
- Pairs with 36" wide wall cabinets, sold separately—see Wall Cabinets section
- Refrigerator Return Kit does not create a stand-alone cabinet; must be anchored to other cabinets/wall studs to be secure

**96" HIGH**

RR96

**Oven Filler**



- Fillers are 3/4" plywood finished on the face only

**91½" HIGH**

UF392P

**Wall & Base Fillers**

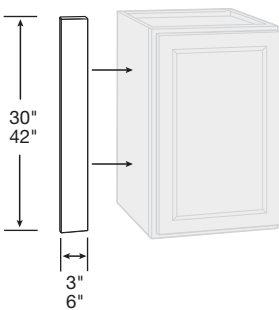

- Fillers are 3/4" plywood finished on the face only

**3" FILLER**

UF3P  
UF342P

**6" FILLER**

UF6P  
UF642P

**Sliding Shelf Kit**

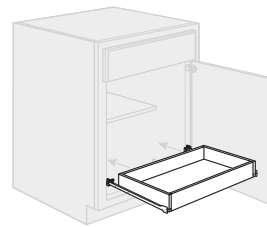

- Ball-bearing drawer glides
- Hardwood drawer box SSK24 fits in 24" wide base
- Hardwood drawer box SSK30 fits in 30" wide base
- Ready to assemble accessory kit requiring field installation
- Kit includes sliding shelf and all hardware

SSK24  
SSK30



## Accessory Item Specifications

### Dishwasher Return

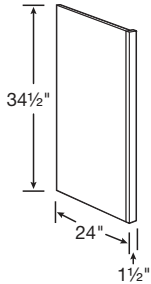

- Reversible for left or right installation
- Exterior finish to match
- Field trimmable to 1"
- Can be notched for toe kick in the field

**34 1/2" HIGH**

DWR1\_5

### Decorative Island End Panel Kit

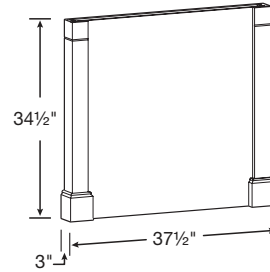

- One post ships loose
- Panel can be cut to accommodate different depths

**34 1/2" HIGH**

ISLAND PANEL KIT

### Finished Shelves

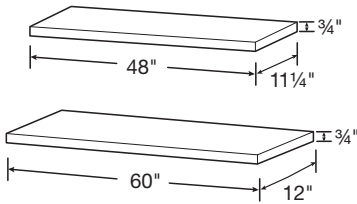

- 3/4" depth difference between shelf lengths
- Laminate finish on five sides

**48" WIDE**

**11 1/4" Deep**  
FS4812

**60" WIDE**

**12" Deep**  
FS6012

### Decorative Matching Doors

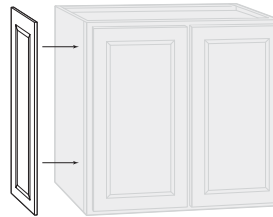

**WALL**

**12" Deep**  
DMDW30  
DMDW36  
DMDW42

**BASE**

15" Deep	18" Deep	24" Deep
DMDW30 15D	DMDW30 18D	DMDW30 24D

### Toe Kick

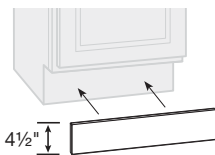

- 91 1/2" long

BTK8

### Countertop Corbel

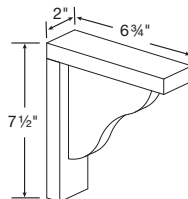

- For decorative use only

CS8

### Cabinet Repair Material

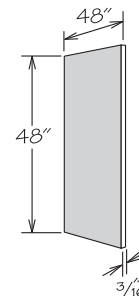

- Features 3/16" MDF finished on one side with a natural woodgrain look

BACK-W48X48



**Cabinet Floor Material**

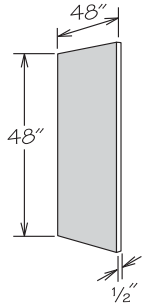

- Features 1/2" thick particleboard finished on both sides with a natural woodgrain look

FLOOR48X48

**Cleats**

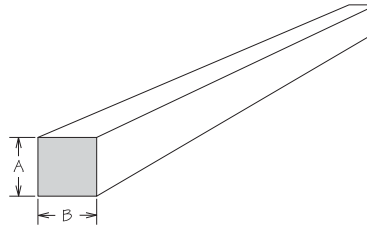

- Unfinished

	A	B	LENGTH
HWC 1/2X1/2X91.5	1/2"	1/2"	91 1/2"
HWC 3/4X3/4X91.5	3/4"	3/4"	91 1/2"
HWC 1X2X91.5	3/4"	1 1/2"	91 1/2"
HWC 2X4X91.5	1 1/2"	3 1/2"	91 1/2"

**Molding Specifications**

**Crown Moldings**

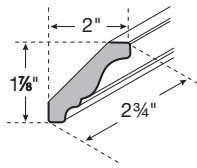

TRADITIONAL CROWN

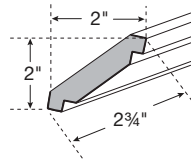

SHAKER CROWN

- 91 1/2" long
- Bold line indicates finished surfaces

**TRADITIONAL CROWN**

CM8

**SHAKER CROWN**

ACM8

**Light Rail Molding**

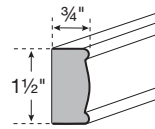

- 91 1/2" long
- Bold line indicates finished surfaces

**DECORATIVE EDGE**

LBM8

**Molding Stock**

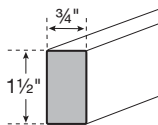

- 91 1/2" long
- Bold line indicates finished surfaces

**SQUARE EDGE**

SS1\_596

**Base Molding**

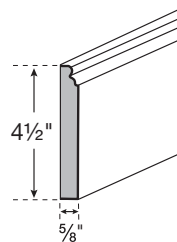

- 91 1/2" long
- Bold line indicates finished surfaces

**BASE**

CLBM8



## Trim Molding

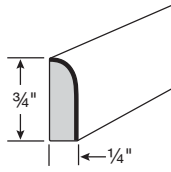

SCRIBE

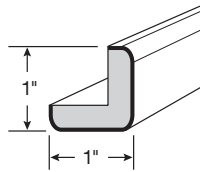

OUTSIDE CORNER

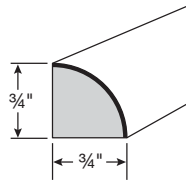

QUARTER ROUND

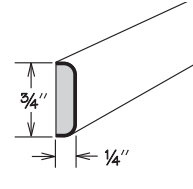

BATTEN

- 91 1/2" long
- Bold line indicates finished surfaces

### SCRIBE

SM8

### OUTSIDE CORNER

OCM8

### QUARTER ROUND

SHM8

### BATTEN

BM8

## Hardware Specifications

### Classic Knob | Satin Nickel



KNOB 1173SN

### Classic Pull | Satin Nickel



- 3" center
- Overall length 4 3/8"

PULL 1708SN

### T-Bar Pull | Satin Nickel



- 3" center
- Overall length 5"

PULL 1701SN



Chatham Umber



# Functional Kitchen Upgrades

**Smart additions increase functionality for a kitchen that's a pleasure to use.**

Functional additions help homeowners unclutter their counters and drawers. They get more work and storage space, and instant access to kitchen tools. These additions make life in the kitchen a piece of cake.



Standard Butt Doors on Cabinets 27" Wide and Up



Fully Concealed and Adjustable Hinges



Island End Panels



Refrigerator Return Kit



Fully Assembled Wastebasket Pull-Out



3-Drawer Base



# Important Information

## 1-Year Limited Warranty

1-year limited warranty applies to Origins by Timberlake cabinets. Timberlake hereby warrants to the original homeowner, for residential applications only, that all cabinets and accessories manufactured and sold by Timberlake are free from defects in material and workmanship for a period of one year from the date: (a) that you purchase your new home, or (b) that you install new Timberlake cabinets or accessories in your remodeled home, as the case may be. This warranty is expressly limited to repair or replacement of the defective part at the discretion of Timberlake and does not include labor for removal or replacement. This warranty does not extend to defects caused by improper handling, storage, installation, assembly or disassembly, intentional damage, product modifications, exposure to the elements including humidity which may result in warping or splitting, accidental misuse, abuse, or negligence.

Natural woods may vary in texture, color, and wood grain, and exhibit subtle changes as they age. For example, wood joints may eventually have visible cracking around the joint area, and cabinet colors may darken or lighten over time. Sunlight, smoke, moisture, household cleaners, and other environmental conditions may cause materials to vary from their original color and/or to warp, split, or crack. These variations are considered to be the nature of the material in relation to its environmental exposure and are not covered under this warranty.

## Limitations & Disclaimers

TIMBERLAKE MAKES NO OTHER WARRANTIES OTHER THAN THOSE SET FORTH HEREIN, AND ALL OTHER WARRANTIES ARE HEREBY DISCLAIMED. THE IMPLIED WARRANTIES OF MERCHANTABILITY AND FITNESS FOR A PARTICULAR PURPOSE ARE LIMITED IN DURATION TO THE LENGTH OF THE HOMEOWNER'S WARRANTY PERIOD. THE LIMITED WARRANTIES SET FORTH HEREIN ARE LIMITED TO THE FIRST AND ORIGINAL HOMEBUYER, AS THE CASE MAY BE, AND ARE NOT TRANSFERABLE THEREAFTER. IN NO EVENT SHALL TIMBERLAKE BE LIABLE FOR INCIDENTAL OR CONSEQUENTIAL DAMAGES TO THE HOMEOWNER OR TO ANY THIRD PARTY, INCLUDING, WITHOUT LIMITATION, DAMAGES ARISING FROM PERSONAL INJURY, LOST PROFITS, LOSS OF BUSINESS OPPORTUNITY, LOSS OF PROPERTY, ECONOMIC LOSSES, OR STATUTORY OR EXEMPLARY DAMAGES, WHETHER FROM NEGLIGENCE, WARRANTY, STRICT LIABILITY, OR OTHERWISE. Some states do not allow the exclusion or limitation of incidental or consequential damages, or limitations on how long an implied warranty lasts, so the above limitations and exclusions may not apply to you. This warranty gives you specific legal rights, and you may also have other rights, which vary from state to state.

## Claims

All claims for defective cabinets and accessories must be submitted to Timberlake in writing and must specify the defects present in the cabinets and accessories. After Timberlake has had an opportunity to inspect the cabinets and accessories, they will, at their discretion, either replace defective cabinets and accessories or repair any defects in the cabinets and accessories. All claims must be submitted to the following address: Timberlake Claims Department, Post Office Box 1980, Winchester, Virginia 22604.

## Warranty Information for Commercial Purchasers

To merchants who purchase Timberlake cabinets and accessories for resale in any form, including builders, dealers and distributors, Timberlake extends the following warranty: Timberlake will replace, without charge, any cabinet and accessory that is not saleable because of defects in material or manufactured workmanship discovered within one year from the date of delivery to merchant. Notice of claim under this warranty must be given promptly, in no case later than ninety (90) days after defect becomes known to merchant. THIS WARRANTY IS IN LIEU OF ALL OTHER WARRANTIES, EXPRESS OR IMPLIED. TIMBERLAKE HEREBY DISCLAIMS ALL IMPLIED WARRANTIES, INCLUDING THE WARRANTIES OF MERCHANTABILITY AND FITNESS FOR A PARTICULAR PURPOSE. THE REMEDY OF REPLACEMENT IS THE SOLE AND EXCLUSIVE REMEDY FOR TIMBERLAKE'S OBLIGATIONS ARISING FROM THE SALE OF ITS CABINETS AND ACCESSORIES. IN NO EVENT WILL TIMBERLAKE BE LIABLE FOR INCIDENTAL OR CONSEQUENTIAL LOSS OR DAMAGES, including, without limitation, costs of installation, removal or reinstallation, damage to other property, loss of profits, loss of goodwill, or other economic loss, whether such incidental or consequential loss or damage is claimed on account of breach of warranty, breach of contract, negligence, strict liability in tort, or any other legal theory. CABINETS AND ACCESSORIES SOLD FOR RESALE ARE ALL SUBJECT TO THESE TERMS, AND ALL OFFERS ARE EXPRESSLY CONDITIONED UPON ACCEPTANCE OF THESE TERMS.





**20  
23**



**TIMBERLAKE<sup>®</sup>**  
C A B I N E T R Y | BUILT BY  
S E R V I C E

**P.O. Box 1980  
Winchester, Virginia 22604  
[www.timberlake.com](http://www.timberlake.com)  
© 2023 American Woodmark Corporation  
9/20 TBL97384 5M**

Photography is for illustration purposes only. Actual colors may vary slightly due to the printing process. For actual color selections, please consult your Timberlake representative. Every effort was made to assure accuracy of the information contained herein at the time of printing; however, Timberlake makes no representations to such accuracies. If you would like further clarification about any of our products or processes, please call Timberlake Customer Care.